

*The elegance of the circle.*  
**MIKO** [Range]



Façade



| Bollard



| Urban



**Advanced**  
LIGHTING TECHNOLOGIES

 **Arcluce**

## MIKO [Range]

---

### The coordinated Range for every lighting project

MIKO Range comprises three types of products that allow to design aesthetically coordinated projects with high visual comfort. High resistant and performing materials are used to assure durability and quality of the series.



## Applications



### Façade

Both for indoor and outdoor lighting, MIKO Façade has an high protection degree (IP66).



### Bollard

Elegant design to add a stylish touch to residential and urban environments.



### Urban

MIKO Grande is the future-proof post-top luminaire which does not produce lighting pollution.



**MIKO Grande**  
available with **Zhaga**  
**Book 18** and **Nema**  
**ANSI C136.41**  
connection  
interfaces.

# MIKO Façade

## MIKO wall mounted

Simple and impactful at the same time.

Available in different colors to better satisfy projects requirements, this wall-mounted, die-cast aluminium luminaire emanates a soft light that enhances volumes and materials of indoor and outdoor spaces.



## Façade

versions available

### STANDARD PRODUCT

Wiring	ON/OFF (A)
CCT	3000K (-830 = CRI 80 / CCT 3000)
Colors	● 21 (-21) Aluminium, similar to (RAL 9006)

### OPTIONS AVAILABLE

CCT	4000K (-840 = CRI 80 / CCT 4000)
Colors	<ul style="list-style-type: none"> <li>● 16 (-16) Grey, similar to (RAL 7024),</li> <li>○ 11 (-11) White, similar to (RAL 9016)</li> <li>● 12 (-12) Black, similar to (RAL 9005),</li> <li>● 23 (-23) Corten, similar to (RAL 8011)</li> </ul>



MIKO | Façade



dimensions (mm)

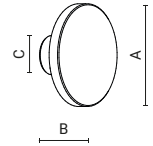

Code	Optic	Watt	Lumen	CRI	CCT	Class	Wiring	Power Supply	A	B	C
0470000A-830-21	 radial	10W	875lm	80	3000K	⊕	ON/OFF	220-240V 50/60Hz	200	100	76



Black colour (-12).



Aluminium colour (-21).



White colour (-11).



Corten colour (-23).



# MIKO Bollard

## A touch of elegance

For every lighting project.

Available in different heights, color temperatures, with no-glare one way or radial optic, this bollard harmoniously illuminates private or public gardens, pathways, pedestrian areas and parks.

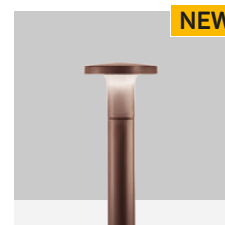

Corten colour (-23).



Green Milan colour (-15).

# Bollard

versions available

### STANDARD PRODUCT

Wiring ON/OFF (A)  
 CCT 3000K (-830 = CRI 80 / CCT 3000)  
 Colors ● 21 (-21) Aluminium, similar to (RAL 9006)

### AVAILABLE OPTIONS

Wiring DALI (B)  
 CCT 4000K (-840 = CRI 80 / CCT 4000)  
 Colors ● 16 (-16) Grey, similar to (RAL 7024),  
 ● 12 (-12) Black, similar to (RAL 9005),  
 ● 23 (-23) Corten, similar to (RAL 8011),  
 ● 15 (-15) Green Milan, similar to (RAL 6005)



MIKO | one way

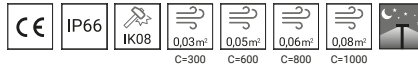

dimensions (mm)

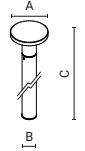

Code	Optic	Watt	Lumen	CRI	CCT	Class	Wiring	Power Supply	A	B	C
0872004A-830-21	one way	10W	1000lm	80	3000K	☐	ON/OFF	220-240V 50/60Hz	200	76	300
0872005A-830-21	one way	10W	1000lm	80	3000K	☐	ON/OFF	220-240V 50/60Hz	200	76	600
0872006A-830-21	one way	10W	1000lm	80	3000K	☐	ON/OFF	220-240V 50/60Hz	200	76	800
0872007A-830-21	one way	10W	1000lm	80	3000K	☐	ON/OFF	220-240V 50/60Hz	200	76	1000

MIKO | radial

Code	Optic	Watt	Lumen	CRI	CCT	Class	Wiring	Power Supply	A	B	C
0872000A-830-21	radial	20W	1700lm	80	3000K	☐	ON/OFF	220-240V 50/60Hz	200	76	300
0872001A-830-21	radial	20W	1700lm	80	3000K	☐	ON/OFF	220-240V 50/60Hz	200	76	600
0872002A-830-21	radial	20W	1700lm	80	3000K	☐	ON/OFF	220-240V 50/60Hz	200	76	800
0872003A-830-21	radial	20W	1700lm	80	3000K	☐	ON/OFF	220-240V 50/60Hz	200	76	1000

### TECHNICAL INFORMATION

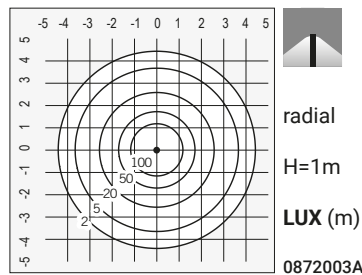
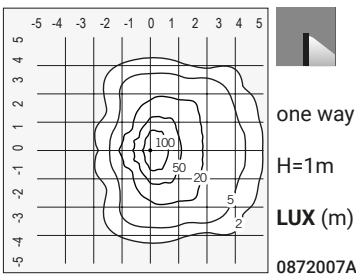

MIKO Bollard available in 4 heights: 300, 600, 800 e 1000mm.

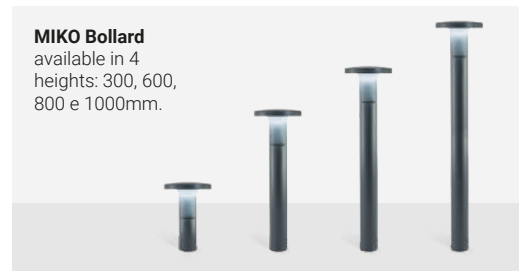

ACCESSORIES	Description	Weight
1099396X-21	Zinc-coated and painted steel base plate with zinc-coated steel stud bolts. 140 mm high.	0,40Kg
1099334X	Hot-dipped zinc-coated steel basement for ground anchoring.	1,70Kg
1099339X	Zinc-coated steel spike. (only for 300mm high bollards).	0,25Kg
1099335X	Hot-dipped zinc-coated steel basement for ground anchoring with internal reinforcement for MIKO bollard 300mm - internal reinforcement H 124mm	1,50Kg
1099336X	Hot-dipped zinc-coated steel basement for ground anchoring with internal reinforcement for MIKO bollard 600mm - internal reinforcement H 424mm	2,30Kg
1099337X	Hot-dipped zinc-coated steel basement for ground anchoring with internal reinforcement for MIKO bollard 800mm - internal reinforcement H 624mm	2,90Kg
1099338X	Hot-dipped zinc-coated steel basement for ground anchoring with internal reinforcement for MIKO bollard 1000mm - internal reinforcement H 824mm	3,50Kg
1099259X	Junction box IP68 - 4 ways - 2/3 poles.	0,05Kg

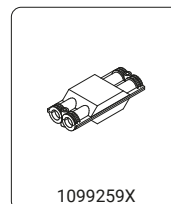
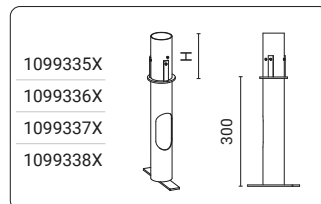
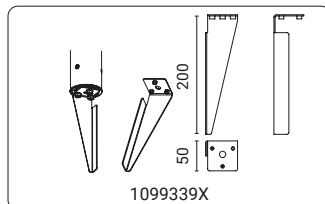
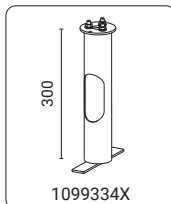
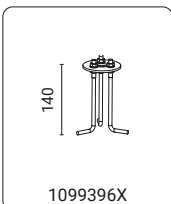

## MIKO Grande

Future-proof lighting.

Lighting is playing a central role in building and shaping smart cities. MIKO Grande is equipped with connection interfaces and it can be installed on wall by means of pole heads, or on single/double pole attachments.

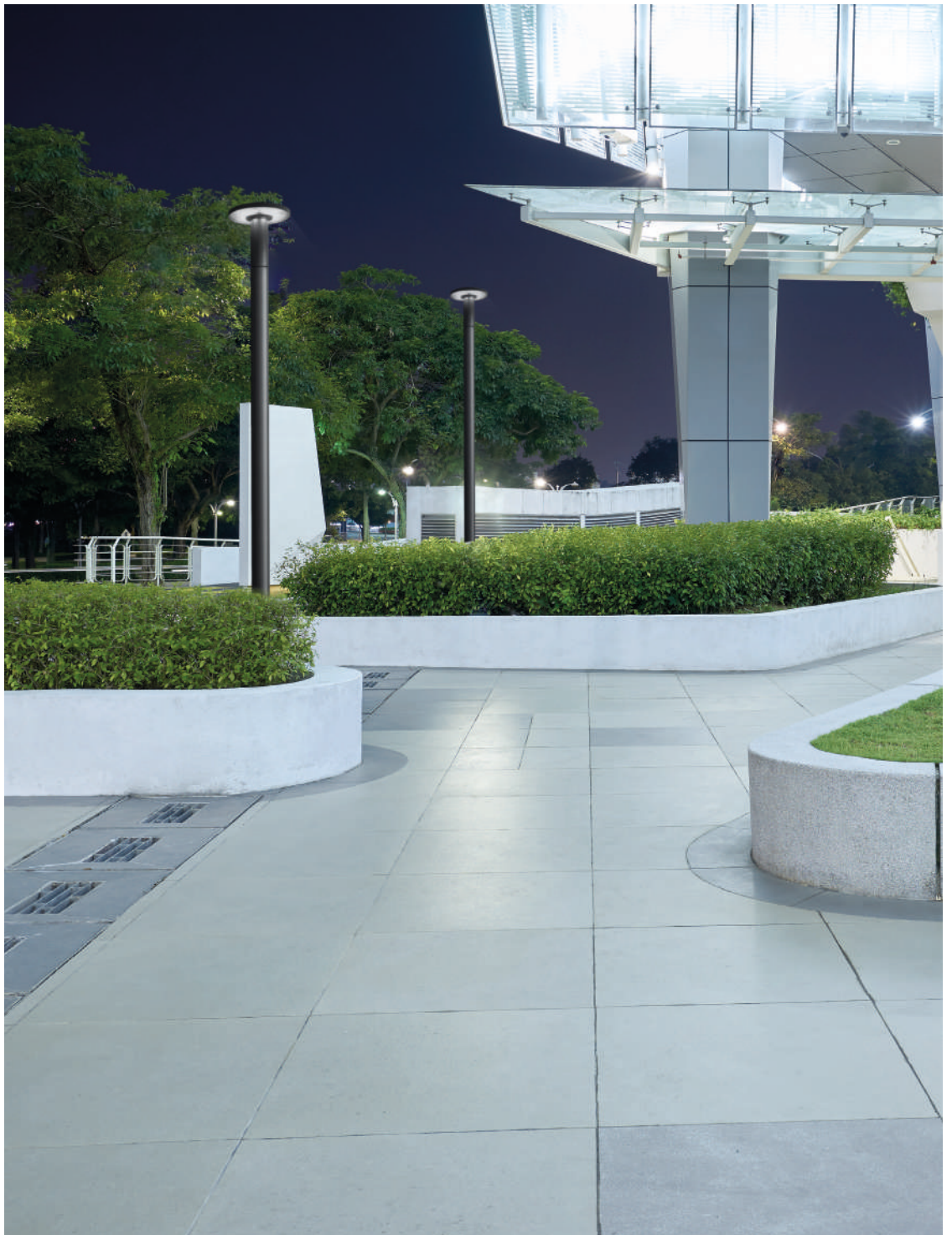



## Urban lighting

available versions

### STANDARD PRODUCT

Wiring	ON/OFF (A)
CCT	4000K (-840 = CRI 80 / CCT 4000)
Colors	● 21 (-21) Aluminium, similar to (RAL 9006)

### AVAILABLE OPTIONS

Wiring	DALI (B), BIP (E)
CCT	3000K (-830 = CRI 80 / CCT 3000)
Colors	● 16 (-16) Grey, similar to (RAL 7024), ● 12 (-12) Black, similar to (RAL 9005)









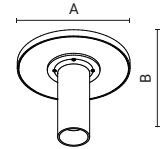



MIKO Grande | comfort



dimensions  
(mm)



Code	Optic	Watt	Lumen	CRI	CCT	Class	Wiring	Power Supply	A	B	C
0886012A-840-21	 type II	30W	3100lm	80	4000K	☐	ON/OFF	220-240V 50/60Hz	360	305	-
0886013A-840-21	 type II	48W	4800lm	80	4000K	☐	ON/OFF	220-240V 50/60Hz	360	305	-
0886014A-840-21	 type III	30W	3300lm	80	4000K	☐	ON/OFF	220-240V 50/60Hz	360	305	-
0886015A-840-21	 type III	48W	5100lm	80	4000K	☐	ON/OFF	220-240V 50/60Hz	360	305	-
0886016A-840-21	 type IV	30W	3400lm	80	4000K	☐	ON/OFF	220-240V 50/60Hz	360	305	-
0886017A-840-21	 type IV	48W	5200lm	80	4000K	☐	ON/OFF	220-240V 50/60Hz	360	305	-
0886018A-840-21	 type IV-L	30W	3300lm	80	4000K	☐	ON/OFF	220-240V 50/60Hz	360	305	-
0886019A-840-21	 type IV-L	48W	5100lm	80	4000K	☐	ON/OFF	220-240V 50/60Hz	360	305	-
0886010A-840-21	 type VS	30W	3200lm	80	4000K	☐	ON/OFF	220-240V 50/60Hz	360	305	-
0886011A-840-21	 type VS	48W	5400lm	80	4000K	☐	ON/OFF	220-240V 50/60Hz	360	305	-









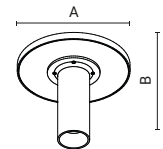

MIKO Grande | performance



dimensions  
(mm)



Code	Optic	Watt	Lumen	CRI	CCT	Class	Wiring	Power Supply	A	B	C
0886002A-840-21	 type II	30W	3400lm	80	4000K	☐	ON/OFF	220-240V 50/60Hz	360	305	-
0886003A-840-21	 type II	48W	5300lm	80	4000K	☐	ON/OFF	220-240V 50/60Hz	360	305	-
0886004A-840-21	 type III	30W	3600lm	80	4000K	☐	ON/OFF	220-240V 50/60Hz	360	305	-
0886005A-840-21	 type III	48W	5600lm	80	4000K	☐	ON/OFF	220-240V 50/60Hz	360	305	-
0886006A-840-21	 type IV	30W	3700lm	80	4000K	☐	ON/OFF	220-240V 50/60Hz	360	305	-
0886007A-840-21	 type IV	48W	5700lm	80	4000K	☐	ON/OFF	220-240V 50/60Hz	360	305	-
0886008A-840-21	 type IV-L	30W	3600lm	80	4000K	☐	ON/OFF	220-240V 50/60Hz	360	305	-
0886009A-840-21	 type IV-L	48W	5600lm	80	4000K	☐	ON/OFF	220-240V 50/60Hz	360	305	-
0886000A-840-21	 type VS	30W	3500lm	80	4000K	☐	ON/OFF	220-240V 50/60Hz	360	305	-
0886001A-840-21	 type VS	48W	5900lm	80	4000K	☐	ON/OFF	220-240V 50/60Hz	360	305	-

See technical information about "performance" versions in the following pages.

# MIKO Urban

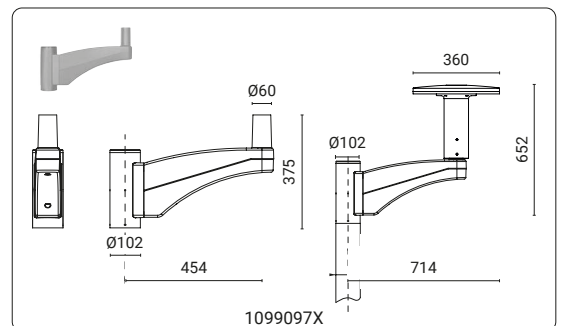
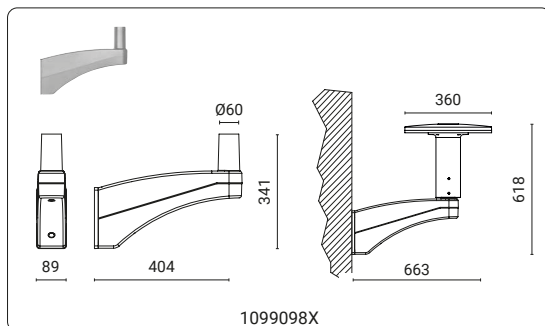

## Urban lighting

### available pole installations

- suitable for pole with **Ø 60mm** reduction (H=100mm) - See accessory Code: **1099566X-21**

- suitable for pole with **Ø 76mm** reduction (H=100mm) - See accessory Code: **1099567X-21**



#### TECHNICAL INFORMATION (performance)

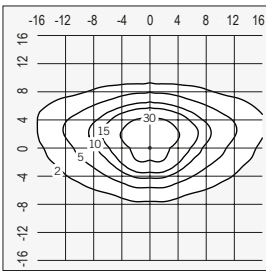

type II  
H=5m  
LUX (m)  
0886003A

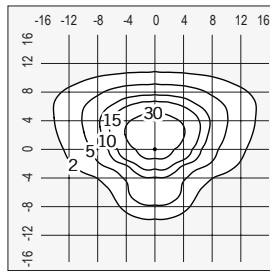

type III  
H=5m  
LUX (m)  
0886005A

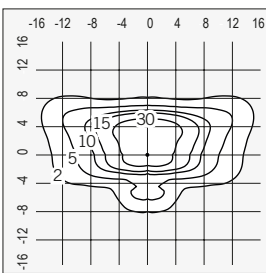

type IV  
H=5m  
LUX (m)  
0886007A

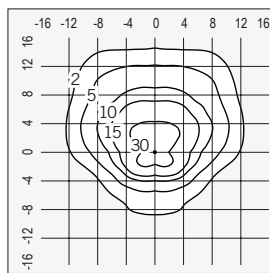

type IV-L  
H=5m  
LUX (m)  
0886009A

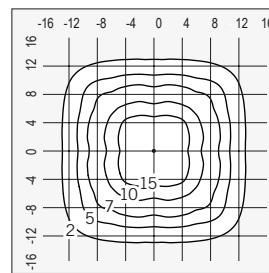

type VS  
H=5m  
LUX (m)  
0886001A

ACCESSORIES	Description	Weight
1099098X-21	Coated die-cast aluminium wall bracket for arm Ø 60 mm.	2,50Kg
1099097X-21	Coated die-cast aluminium single pole attachment.	3,50Kg
1099096X-21	Coated die-cast aluminium double pole attachment.	6,00Kg
1099566X-21	Locking ring and counter-ring for pole Ø60mm	0,03Kg
1099567X-21	Locking ring and counter-ring for pole Ø76mm	0,05Kg

