

Urban lighting

# LUNIO





## LUMINAIRE

- Body in die-cast aluminum alloy with low copper content (EN 47100).
- QUALICOAT2 validated multi-stage painting process tested in salt spray according to ISO 9227 for aggressive environments of class C4. On request, resistance class C5.
- Gaskets in silicone rubber with controlled hardness, stabilized against UV rays.
- External screws in AISI 316 stainless steel chemically passivated to contrast galvanic corrosion. Color of the screws combined with the color of the fixture for better aesthetic coordination.
- Wiring on removable galvanized steel tray.
- Knife-switch for automatic power disconnection when opened.
- Integrated LED drivers equipped with protection against overtemperatures and mains spikes or surges both in common and differential mode. Future-proof versions equipped with DALI certified LED drivers for using intelligent modules on Zhaga Book 18 or NEMA ANSI C136.41 sockets.
- Reflector made of anodized aluminium with non-iridescent specular finishing.
- High quality LED sources mounted on metal-based modules for better thermal load management and characterized according to LM-80 methodology for longevity and IES TM-30 for colorimetric characteristics. High color consistency <math><3\text{SDCM}</math>, for guaranteed long life, in compliance with installation requirements, for more than 60,000 hours with parameters L80B20.
- Appliance built in compliance with EN 60598-1 and EN 60598-2-3 standards, complete with CE marking in compliance with EU directives.

## INSTALLATION

- Post top installation, requires  $\text{Ø}60\text{mm}$  tenon for 100mm height. Available accessories for single or multiple fixing on the arm.
- Supplied complete with cable (0.15m or, on request, pole length) with IP66 socket-plug connector with locking ring nut for cables from 9 to 12mm.

Available versions with Casambi and other modern control systems, for more information see "Controlling the Light" section.

**Available wired with Zhaga Book 18 or NEMA ANSI C136.41 (5-pin) and waterproof cover.**

### STANDARD PRODUCT

Wiring	ON/OFF (A)
CCT	4000K (-840 = CRI 80 / CCT 4000)
Colour	● 21 Aluminium (similar to RAL 9006)

### AVAILABLE OPTIONS

DALI (B), BIP (E)
3000K (-830 = CRI 80 / CCT 3000)
● 12 Black (similar to RAL 9005)
● 16 Grey (similar to RAL 7024)



📍 Urban Belysning Brekкетrappa - Skien, Norway

Urban lighting

# LUNIO

## PERFORMANCE







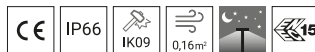
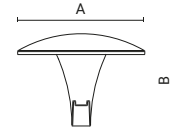

### STANDARD COLOUR

 21

### DIMENSIONS



Code	Optic	Luminaire		CRI	CCT	Class	Wiring	Power Supply	A mm	B mm	C mm
		Watt	Lumen								
0875002A-840-21	 type IV	30W	2950lm	80	4000K	□	ON/OFF	220-240V 50/60Hz	520	377	-
0875006A-840-21	 type IV	43W	4050lm	80	4000K	□	ON/OFF	220-240V 50/60Hz	520	377	-
0875014A-840-21	 type IV	57W	5700lm	80	4000K	□	ON/OFF	220-240V 50/60Hz	520	377	-
0875029A-840-21	 type IV	69W	6900lm	80	4000K	□	ON/OFF	220-240V 50/60Hz	520	377	-
0875010A-840-21	 type V	41W	4300lm	80	4000K	□	ON/OFF	220-240V 50/60Hz	520	377	-
0875018A-840-21	 type V	57W	6050lm	80	4000K	□	ON/OFF	220-240V 50/60Hz	520	377	-
0875022A-840-21	 type V	80W	8400lm	80	4000K	□	ON/OFF	220-240V 50/60Hz	520	377	-
0875030A-840-21	 type V	110W	10150lm	80	4000K	□	ON/OFF	220-240V 50/60Hz	520	377	-

The **photo** represents the family product range. You can see the correct image of each product (code) on the website.

## LIGHTING DATA

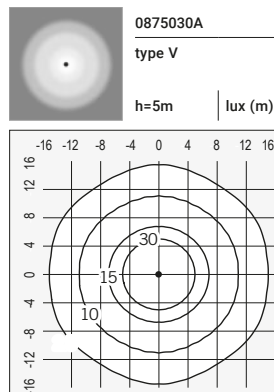
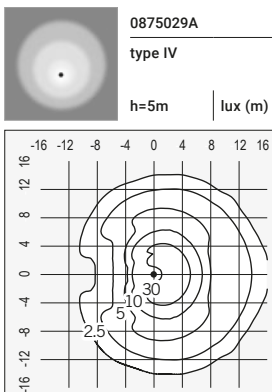

LED driver included.

 Available on request:  
versions with Future-Proof,

 Available on request:  
versions with CCT 2200K.

# LUNIO

## COMFORT









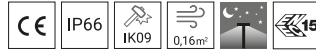
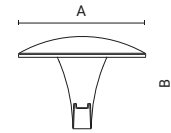

### STANDARD COLOUR



### DIMENSIONS



Code	Optic	Luminaire		CRI	CCT	Class	Wiring	Power Supply	A mm	B mm	C mm
		Watt	Lumen								
0875001A-840-21	 type IV	30W	2550lm	80	4000K	□	ON/OFF	220-240V 50/60Hz	520	377	-
0875005A-840-21	 type IV	43W	3600lm	80	4000K	□	ON/OFF	220-240V 50/60Hz	520	377	-
0875013A-840-21	 type IV	57W	4950lm	80	4000K	□	ON/OFF	220-240V 50/60Hz	520	377	-
0875027A-840-21	 type IV	69W	6000lm	80	4000K	□	ON/OFF	220-240V 50/60Hz	520	377	-
0875009A-840-21	 type V	41W	3950lm	80	4000K	□	ON/OFF	220-240V 50/60Hz	520	377	-
0875017A-840-21	 type V	57W	5450lm	80	4000K	□	ON/OFF	220-240V 50/60Hz	520	377	-
0875021A-840-21	 type V	80W	7500lm	80	4000K	□	ON/OFF	220-240V 50/60Hz	520	377	-
0875028A-840-21	 type V	110W	9050lm	80	4000K	□	ON/OFF	220-240V 50/60Hz	520	377	-

The **photo** represents the family product range. You can see the correct image of each product (code) on the website.

## LIGHTING DATA

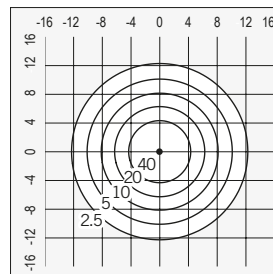
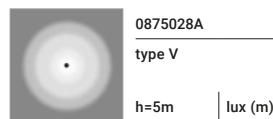
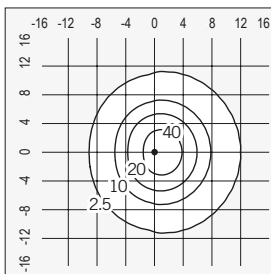
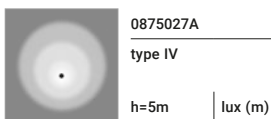



Urban lighting

# LUNIO

## ACCESSORIES

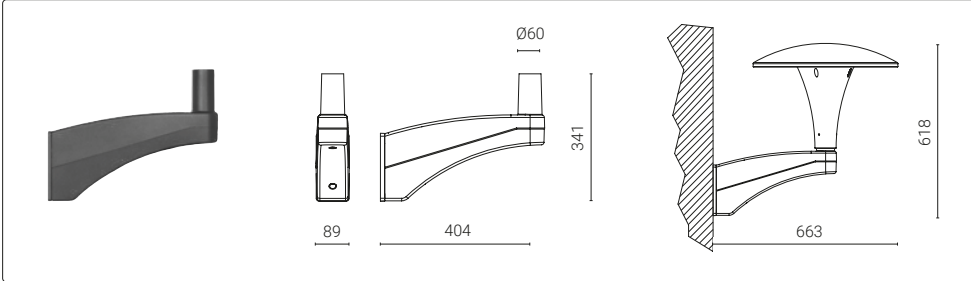

Code	Kg
<b>1099098X-21</b>	2,50

Wall bracket.

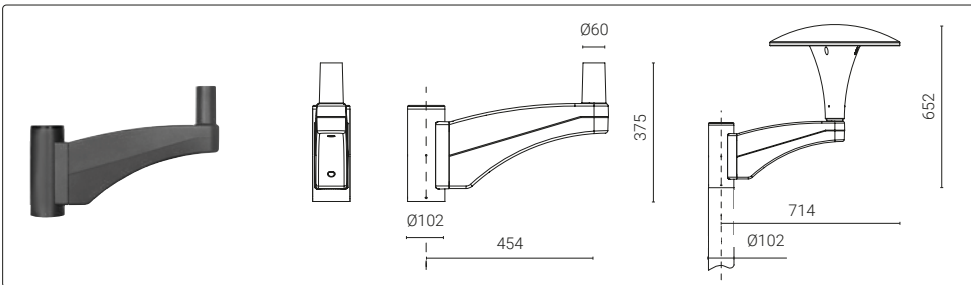

Code	Kg
<b>1099097X-21</b>	3,50

Post-top mounting for single fixture for Ø 102 mm.

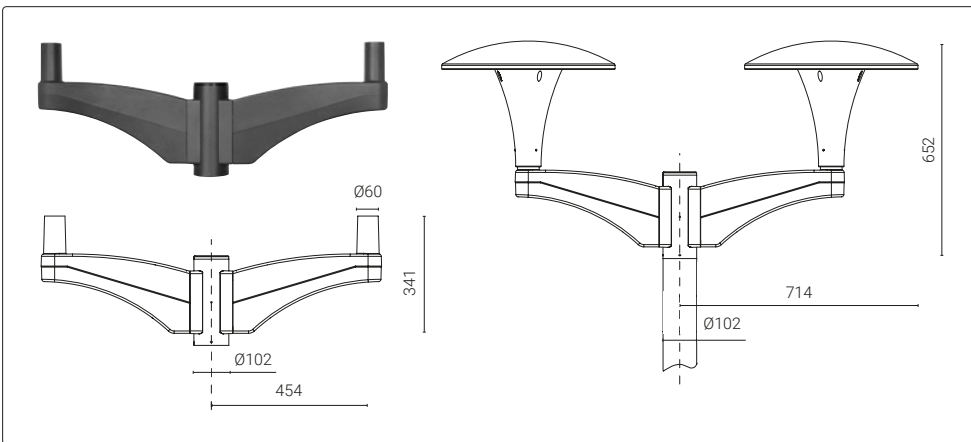

Code	Kg
<b>1099096X-21</b>	6,00

Post-top mounting for double fixture for Ø 102 mm.

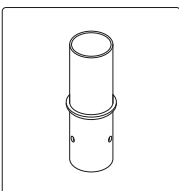

Code	Kg
<b>1097049X-21</b>	2,5 kg

Adapter for pole reduction from Ø76 to Ø60

- 1097069X-21** - 2.5 Kg - from Ø89 to Ø60
- 1097070X-21** - 2.5 kg - from Ø102 to Ø60
- 1097071X-21** - 2.5 kg - from Ø114 to Ø60



Photorealistic rendering.

